

Article number: 2310301242ESD

Description: E+G Antistatic base for levelling elements
LV.A-60-24-ESD-C

Measures

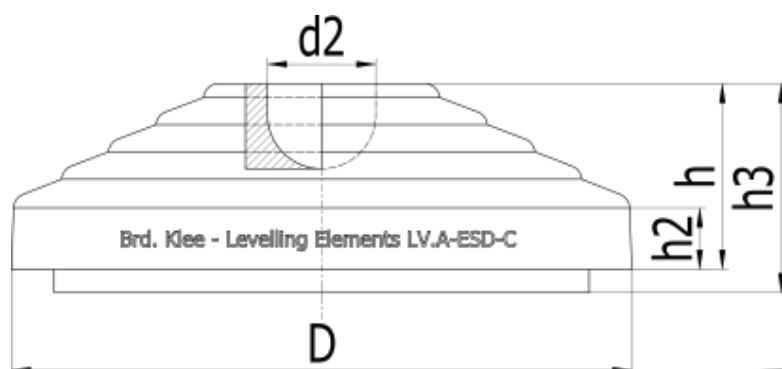

D	= 60
d2	= 24
h	= 24
h2	= 9
h3	= 27
N	= 18000
Weight in g	= 29